

One Range, One Result, One Name

Fenner[®] Product Solutions

- > INVERTERS
- > MOTORS
- > GEARED MOTORS
- > GEARED DRIVES
- > FRICTION BELTS
- > SYNCHRONOUS BELTS
- > CHAIN DRIVES
- > COUPLINGS
- > SHAFT FIXINGS

Fenner[®]

THE MARK OF ENGINEERING EXCELLENCE

The Complete Drive Solution

Fenner® Product Solutions - tried and trusted worldwide for over 150 years.





Dedicated to continual improvement for over 150 years, Fenner has long been a trusted brand worldwide across a wide range of industry sectors and has a proven track record in supplying added-value problem solving products for power transmission applications.

More and more companies are finding that the synergies gained by purchasing the whole of their drive train from Fenner makes commercial and engineering sense.

Fenner - a brand that can be trusted

Continued investment in research and development and a strong desire to innovate keeps Fenner at the forefront of drive train technology. Fenner products are renowned for delivering rugged dependable construction and a reliable and efficient performance - every time. Fenner is a brand that can be trusted to get the job done.

Fenner - quality that can be relied upon.

Fenner's worldwide commitment to quality is a guarantee that wherever the project or customer is located, the Fenner products supplied will always meet the most exacting standards. From initial material sourcing, through the manufacturing process and on to product delivery, Fenner delivers quality standards that can be relied upon.

Fenner - driving technology forward

Attention to detail is the key to success and sets Fenner products apart from commodity suppliers. The attributes engineered into Fenner products are derived from many years of practical experience working in some of the most arduous applications and conditions.

One of Fenner's key objectives is to continually drive technology forward.



www.fptgroup.com

- On-Line product selectors
- Installation videos
- Installation and Maintenance Instructions
- Technical Data sheets

Quality Assurance



The Fenner Quality Assurance Initiative forms the foundation on which our complete power transmission range is constructed.

It is a worldwide commitment to quality and a guarantee to our customers that the quality of the products we supply will always meet exacting, agreed and internationally recognised industry standards to ensure Fenner products excel in today's demanding applications.

Product Development

At the core of the initiative is a continuous quest for improvements in product performance, reliability and safety.

Exacting Standards

Incorporating material testing, process control, as well as noise studies, vibration analysis and safety performance checks, our specified controls ensure that only the best is supplied.

Performance

FPT Quality Assurance Initiative was designed to ensure that the Fenner products perform cost effectively, throughout their lifetime to deliver superb customer value underpinned by engineering excellence.

Heritage

Formed in 1861 by Joseph Henry Fenner manufacturing horsehair and leather belts, the brand has grown consistently to become one of the largest suppliers in the world. Synonymous with quality hard wearing products, a feature that remains a cornerstone of the brand today.

Inverters



QD:Flow

Variable Torque 0.75kW - 200kW

The Fenner QD:Flow sets a new standard for dedicated fan & pump control whilst retaining ease of use. Fenner QD:Flow has an innovative design, combined with robust performance to provide powerful flow control and reliability in a compact drive.

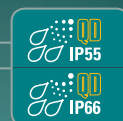

Optional LED or OLED (IP55 & IP66)



Hand Auto

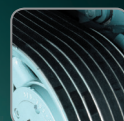

Break Belt Detection



Bluetooth O:Stick Programming



Spin Start



High Quality Long-life Fans

Save Money

- Built-in fan and pump control
- IP55 & IP66 enclosures minimise installation costs

Save Energy

- Built-in energy optimiser
- Built-in-PID control

Save Time

- Simple parameter set up
- Customisable OLED display
- Pluggable terminals

98%
Energy Efficient

Fenner Inverters

Fenner inverters have been designed from first principles to deliver optimum cost savings with no loss of performance. These Inverters are very easy to install and commission and they run from the box in seconds. EMC filters are built in as standard.

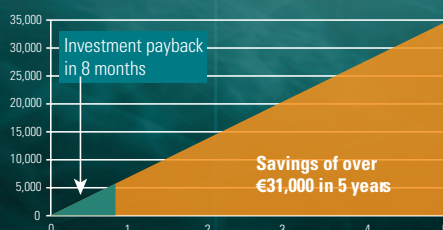



η 98%
Energy Efficient

QD:Neo

Constant Torque 0.75kW - 200kW

Fenner QD:Neo offers the perfect combination of high performance and ease of use, providing a solid solution for even the most demanding applications. Fenner QD:Neo is suitable for use with both standard induction and permanent magnet motors.

High Performance

- Sensorless Vector Control:
Up to 200% torque from 0 speed ensures reliable starting and accurate speed control
- PM Motor Control future proof:
Can be upgraded to the latest high efficiency permanent magnet motors
- I/O & Communications:
Fenner QD:Neo supports a wide range of machine control systems interfaces



η 98%
Energy Efficient

QD:Evo

Easy To Use 0.37kW - 11.0kW

The Fenner QD:Evo is a value packed basic drive ideally suited for low power applications that require "best in class" purchase value. Operating from a small space-saving envelope the QD:Evo is fast to set up, simple to use and suitable for most applications.

High Performance

- Easy to install
- Simple keypad control
- 50°C ambient rating for hot, tough applications
- Free lifetime technical support

Optimised Flow Efficiency with QD:Flow

A leading plastics extrusion company contacted their local Fenner Distributor to seek advice on potential energy savings. Following a visit by an approved technical engineer, it was quickly identified that substantial savings could be achieved by electrically controlling the pumps which fed water coolant to the extrusion machines. The existing arrangement meant that the pump worked at full flow even if only one machine was working. Each machine has its own isolator valve which was turned off if the machine wasn't working.

The suggested solution was a 18.5kW Fenner inverter which controlled the flow of the pump on demand, instead of all the time. This resulted in a significant reduction in energy costs with a payback period of less than one year. The customer is now systematically installing Fenner drives on all of their variable torque applications.



Attention to detail makes all the difference...

Because many inverters are placed in low light areas, the keypad is designed to feature OLED technology - making Fenner inverters easier to read and easier to use.

Q:Stick

For fast, accurate repeat programming.



- Upload/download buttons allows for fast copying of parameters between drives
- Infra-red and bluetooth communications capability provides remote control convenience
- Can be programmed by PDA/smart phone

Motors

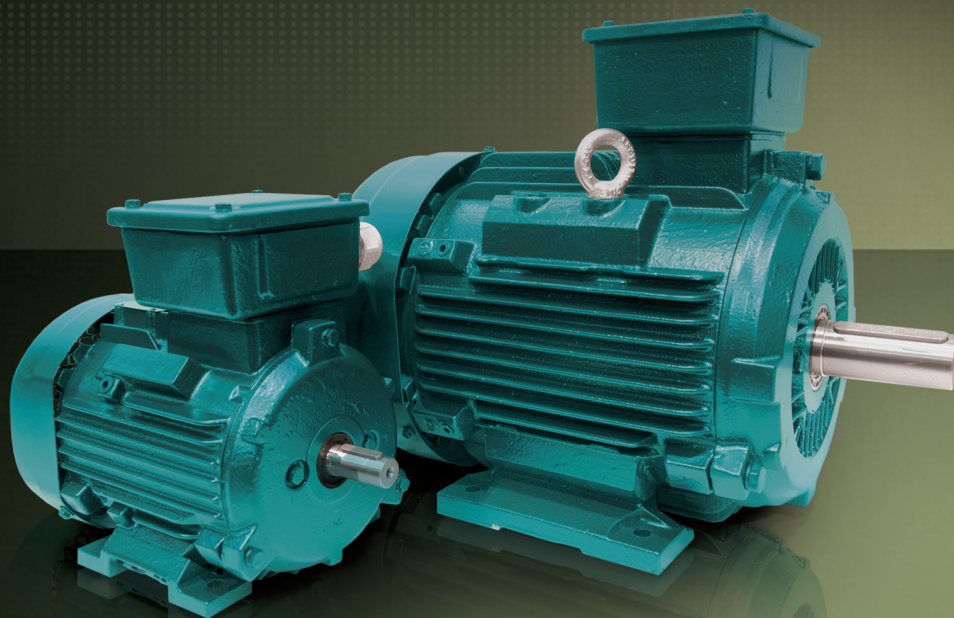

FM:3 Series

Premium Efficiency (IE3)

Electric Motors

The latest addition to the Fenner power transmission product range Fenner FM:3 Series electric motors conform to the latest European electric motor efficiency standard and meet the minimum efficiency performance requirements for IE3 Premium Efficiency.

Built to the exacting standards of the Fenner power transmission range in a rugged, feature packed design the FM:3 motor range delivers an energy efficient, robust solution across a broad power range giving the user both operational excellence and a lower Total Cost of Ownership throughout its lifecycle.

- 160 to 315 frame all Multi Mount design
- All Motors fitted with thermistors terminated in the terminal box
- High quality 63 series bearings from major European manufacturers
- Re-greaseable bearings on 180 frame and above with button type grease nipple
- Drive end bearings fixed
- Two external Earth Fixings on all frames
- Spring lip seals standard on both drive end and none drive end
- B14 and B5 flanges are fitted with lip seals for use on wet gearboxes
- Large Terminal box with two cable entries making connection easy on site
- Symmetrical design allowing the terminal box to be moved towards the fan cowl
- Two lifting eye bolts that are moveable so are always in the best position for a safe lift even after the terminal box position has been moved



Options Available

- Electro-mechanical Brake Kits
- Encoders for speed and positional feedback
- Force Ventilation Fan kits for wide speed range operation with inverter control
- Rain Canopies for vertical, shaft down mounting
- Bearing changes to suit different applications and mounting arrangements

Listed on the Carbon Trust's 'Energy Technology List' the Fenner FM:3 IE3 range of low voltage electric motors qualify for Enhanced Capital Allowance (ECA) which allows claimants to claim back a proportion of the purchase and installation cost from HMRC at the end of the tax year which would reduce the payback period on initial investment.

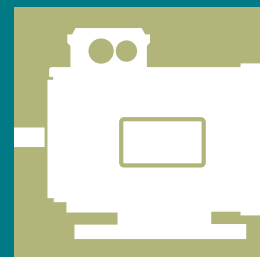

Energy Efficient IE3 Electric Motors from Fenner

It's a well know fact that approximately 70% of industrial energy consumption can be directly attributed to electric motors. The energy used to power electric motors often accounts for a significant part of the electrical energy bill for most businesses - a figure which is set to grow with the rising cost of energy.

Total Cost of Ownership

By far the most important factor in any purchasing decision of industrial electric motors should be its total cost of ownership. With purchase price and maintenance costs representing as little as 3% of an electric motors' lifecycle cost, the remaining 97% can be directly related to the energy cost of running it.

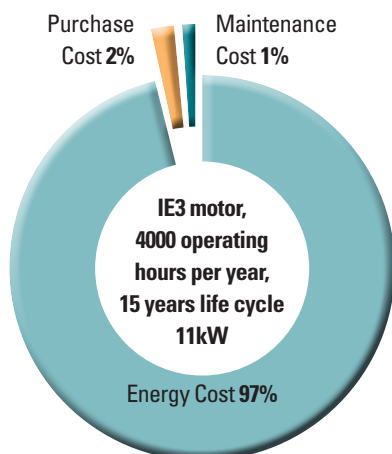

Source : Gambica

In some cases purchase price can be outweighed by energy cost in the first month of an electric motors operation so the energy efficiency rating of the motor is paramount when deciding which motor to invest in.

Recent changes in European standards and legislation have seen the minimum efficiency levels of electric motors re-established under the European standard IEC 60034-30:2008.

The new standard sets out minimum efficiency levels for 2, 4 and 6 pole low voltage (Up to 1000 volts) electric motors from 0.75 to 375kW. The standard also defines an improved efficiency testing method which gives more accurate efficiency measurements than previously employed standards.

Minimum efficiencies are now classified under the following levels

Super Premium Efficiency	IE4
Premium Efficiency	IE3
High Efficiency	IE2
Standard Efficiency	IE1

Efficiency Standard

IEC 60034-30 International Efficiency Code	Efficiency Level
IE4	EFF4
IE3	EFF3
IE2	EFF2
IE1	EFF1
0.75 - 375kW >1000v 2, 4 & 6 pole	EFF3

Efficiency Built-In as Standard

A large building products manufacturer recognised the demand electric motors put on their electrical energy consumption and set about taking steps to tackle the issue. Total cost of ownership has now become the deciding factor for their choice of electric motors and the Fenner FM:3 IE3 range ticks all the boxes when it comes to energy efficiency and TCO.

On a 37kW motor installation that had failed it was calculated that the existing EFF2 machine would consume over 1.84 million kW hours over a 10 year period which equated to 988 tonnes of CO₂ emissions. The same application fitted with a Fenner IE3 motor would use 1.76 million kW hours, a saving of 80,000 kW hours and therefore a significant reduction in running cost over it's lifecycle with the Fenner IE3 motor also reducing CO₂ emissions by 43 tonnes to 945.

With the added benefit of qualification for the UK Enhanced Capital Allowance scheme and the realization of the scrap value of the existing motor the payback period for choosing Fenner IE3 over lower efficiency options was less than 6 months.



Attention to detail makes all the difference...

With thermistors fitted as standard throughout the range and terminated in a generous sized terminal box for ease of installation. Also benefitting from multi-mount feet from 160 to 315 frame the Fenner range has attention to detail and efficiency at its core.

Geared Motors

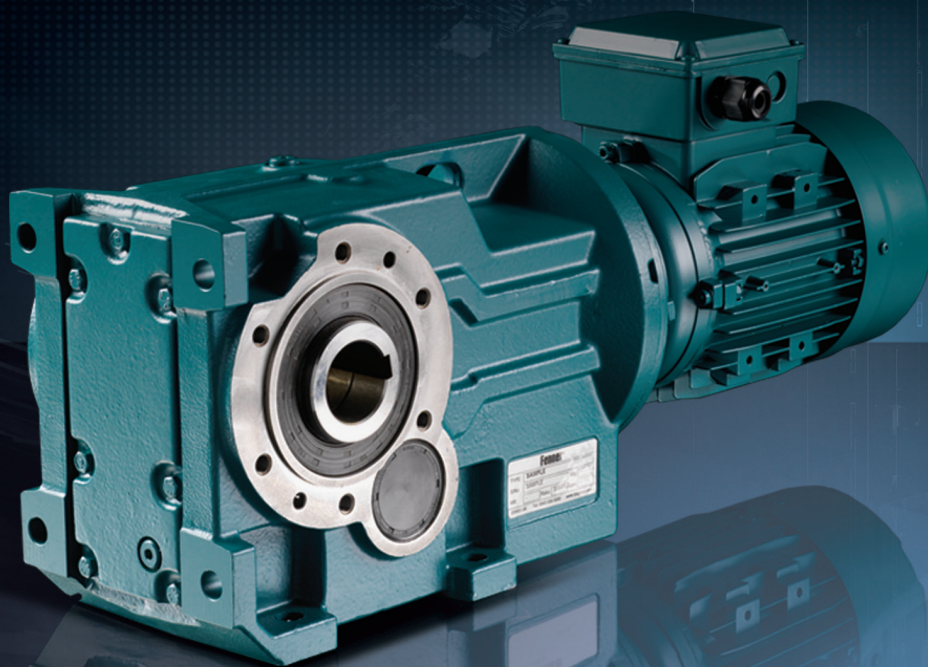

UP TO
η 96%
Energy Efficient



Fenner Geared Motors

Fenner Geared Motors deliver the ultimate in flexibility. Customers can choose from IE2 or IE3 with full ATEX compliance. Special coatings are available for Food manufacturing, Water industry and many other markets.

The Fenner range of gearboxes incorporates a number of design features including: Modular construction, highly efficient pre-reduction and standard mounting platforms, all of which deliver superb value for both individual drives and in integrated systems.

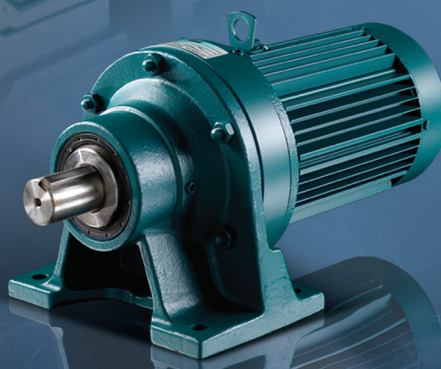

UP TO
η 95%
Energy Efficient

Series K

Bevel Helical Range 0.18kW - 90kW

The Series K range incorporates all Fenner's core design features in a highly efficient yet flexible bevel helical drive. With high load carrying capabilities and increased efficiency over worm units, the right angled Series K range is proven to save energy and reduce running costs.

- Right angled
- Up to 12,300 Nm
- 8:1 to 7250:1 ratios
- Foot, flange or shaft mounting
- ATEX Certification available

Fenner Cyclo

Cycloidal Range 0.12kW - 55kW

The revolutionary design of the Cyclo discs offers smooth and silent operation and excellent resistance to overloads. Extremely high ratios can be achieved within a very small envelope offering high efficiency in a very compact package.

- High overload capacity up to 500% and high efficiency, even at high reduction ratios
- Compact size and reduced noise level
- High reliability with 2 years warranty
- Exceptional life compared to other types of gearing

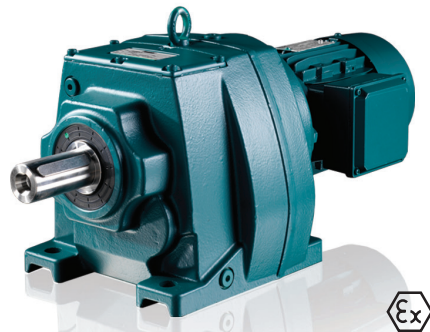

UP TO
96%
Energy Efficient

Series M

Coaxial 0.18kW - 90kW

The innovative Fenner Series M coaxial gearbox is designed to be utilised in a wide variety of situations, combining high load carrying capacity with high efficiency and reliability.

- In-Line
- Up to 11,000Nm
- 5:1 to 11,000:1 ratios
- Foot or flange mounting
- ATEX certification

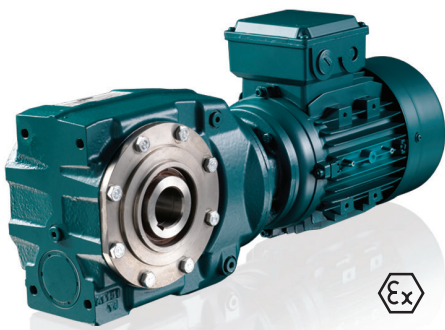

UP TO
92%
Energy Efficient

Series C

Helical Worm 0.18kW - 45kW

Modern design techniques and high quality components enable the Fenner Series C helical worm gear unit to outperform any other Gearbox in terms of lowest cost/Nm. The Series C right angle range provides a highly efficient and compact solution.

- Right angled
- Up to 10,000Nm
- 8:1 to 13,500:1 ratios
- Foot, flange or shaft mounting
- ATEX certification



UP TO
96%
Energy Efficient

Series F

Parallel Shaft 0.18kW - 110kW

The Fenner Series F range is primarily designed as a shaft mounted unit incorporating an integral torque reaction bracket. This range of parallel shaft mounted geared motors and speed reducers offers high efficiency and interchangeability with other leading brands.

- Parallel off-set
- Up to 16,500Nm
- 4.5:1 to 5,700:1 ratios
- Flange or shaft mounting
- ATEX certification

Off-the-shelf Engineered Solutions

A geared motor driving a blender was leaking oil and running very noisily. As the blender could not be taken out of production, a replacement needed to be sourced as a matter of urgency. The OEM quoted a 20 week delivery for a direct replacement at a cost of over £20k. Following discussion with their local Fenner distributor and working alongside Fenner technical specialists, a solution was engineered using a Fenner Series K geared drive.

The units were specified as non-motorised, enabling the customer to use a wedge belt drive from the motor to reducer. This assists with the fitting of the unit, allowing site engineers to move the motor and gearbox as separate units if required. The motors supplied were IE3 premium efficiency, offering the customer additional savings over the previous unit.

The introduction of a Fenner Series K bevel helical, IE3 premium efficiency motor and Fenner Quattro PLUS wedge belt drive gave the customer a rugged, reliable solution in one brand.



Attention to detail makes all the difference...

Fenner Geared Motors are "dry fit" across the range. The dry fit principle allows the user to disconnect the electric motor without oil spillage leaving the gearhead in place, if required, saving costly downtime.

Geared Drives



η UP TO
96%
Energy Efficient

Series P Packaged Drives

The Fenner Series P is not just a gearbox, it's a complete industrial drive solution.

The Series P engineered drive package solution is ideal for both new projects and retrofit upgrades.

Utilising the latest CAD technology the Series P is available pre-installed to a standard or bespoke design baseplate pre-coupled to a high efficiency drive motor and ready to be installed directly to the application.

Series P

Bevel Helical 6.0kW to 4,500kW

The robust Series P gearboxes have a modular construction enabling short lead times. They are available in double, triple and quadruple reduction gear stages having a maximum output torque range of up to 900,000Nm.

- Parallel shaft helical gearboxes
- Right angle bevel-helical units
- Versatile mounting positions
- Motorised or reducer options
- Hollow bore or output shaft mounting
- Ratios up to 500:1

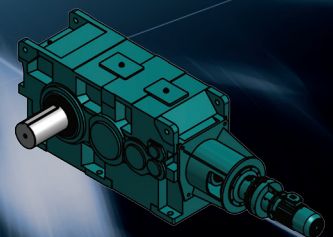



50% Better, 100% Fenner

More Compact, same reliability
in the toughest of conditions



The unique Taper-Grip bush locking system allows Fenner SMSR's to be secured to the driven shaft overcoming mounting difficulties.

Fenner SMSR
Shaft Mounted Speed Reducer
0.25kW - 250kW

The Fenner SMSR PowerPLUS offers a rugged design and a 50% increase in the power to weight ratio over the older versions. The PowerPLUS version is more compact for easier handling and features an increased range of bore sizes.

- Compact, rugged design
- Bore sizes ranging from 20mm to 190mm available
- Metric and imperial reducing bushes available
- Easy fit backstops available

- Transmits 300% more torque
- Accommodates shaft tolerance to h11
- Resistant to fretting corrosion
- Allows easy removal of gear unit

Series W
Worm Box 0.06kW - 15kW

A modern modular designed aluminium worm box available in a vast range of sizes and ratios for cost effective solutions.

- Dimensionally interchangeable with the market leaders
- Versatile mounting
- Excellent mechanical strength whilst being especially lightweight
- Accepts standard IEC electric motors

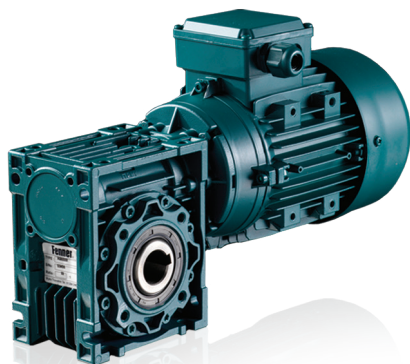

Engineered Simplicity

A UK based aggregates company identified an issue with their existing gearbox on the main field conveyor. With limited access to the plant and with the existing gearbox now obsolete an alternative solution was required that could be installed using the existing fixings and minimal modification to the plant.

With its modular construction and output torque ratings up to 900,000Nm the Fenner Series P would provide an ideal solution to the customer's problem.

An engineered solution comprising Series P industrial reducer, Fenaflex coupling with coupling guard and Fenner FM:3 IE3 Premium Efficiency electric motor all fitted to a bespoke base plate the 'drop in' package solution was delivered to suit the customers planned maintenance window.



**Attention to detail makes
all the difference...**

The industry standard for more than 50 years Fenner geared drives have been developed with the user in mind. The SMSR with its unique Taper-Grip output hub solution reduces fretting corrosion making removal issues a thing of the past.

Transmission Belts - Friction

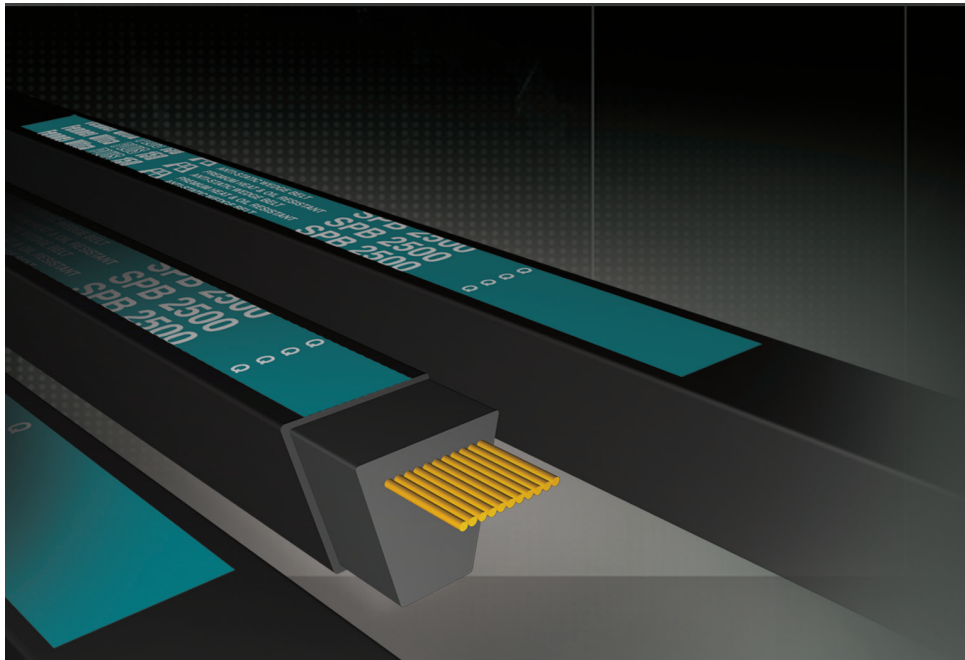

Ultra PLUS 150

Heavy Duty Drive Belt

Fenner Ultra PLUS 150 drive belts are specifically designed for applications where rugged durability is paramount, combining the highest level of performance with the longest service life possible.

- Greater reliability and working life
- Increased power ratings potentially reducing the numbers of belts required and grooves on a pulley
- Length stability, minimal stretch and elongation

η 96%
Energy Efficient



Quattro PLUS

Premium CRE Belt

This CRE belt transmits up to 4 times the power of conventional V belts. The increase in cross sectional rigidity provided by fibre-reinforced polychloroprene contributes significantly to the performance advantages.

- Ideal problem solving belt
- 4x power transmission
- 'One Shot' tensioning - no matching necessary
- Meets industry standards for static conductivity and non-ignition properties
- High efficiency for low running costs

η 95%
Energy Efficient

PowerTwist PLUS

Problem Solving Emergency Belt

Power Twist Plus is the state of the art solution for emergency replacement and fitment into inaccessible locations.

- Made to any length in seconds
- Available in standard (Z, A, B, C), & double sections (AA, BB etc)
- Highly resistant to heat, water, oil, etc
- Use with Fenner ISO standard TaperLock™ pulleys, optionally with RMA pulleys
- Easy to install, rivet-less construction, no tools necessary





Ultra PLUS

Built using advanced technology, Fenner Ultra PLUS achieves economic performance by use of low elongation polyester cords and abrasion resistant impregnated jacket fabric.

- PB® (Precision Build) technology
- Accuracy and stability of length
- 'One Shot' tensioning - no matching necessary
- Meets highest industry standards for static conductivity and non-ignition properties
- Heat and oil resistant

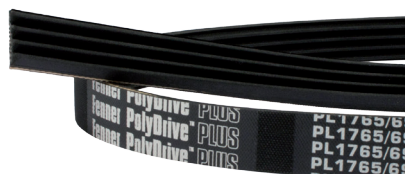

Polydrive PLUS

Suitable for high belt speed applications and capable of operating on high ratio drive systems.

- Available in PJ, PK, PL and PM sections
- Dimensions conform with DIN7867 and ISO9982
- Heat and oil resistant and anti static to ISO1813
- Operates normally between -30°C and +80° C

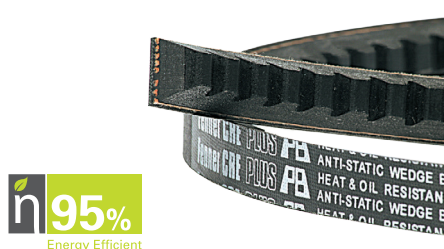

CRE PLUS

Fenner CRE PLUS excels in the high ratio applications used in today's compact drive envelopes, by combining flexibility with structural stability.

- PB® (Precision Build) technology
- Accuracy and stability of length
- 'One Shot' tensioning - no matching required
- Special compounds used to improve flexibility and strength
- Higher running efficiency than wrapped belts



Classic V Belt

Ideal for high ratio or small pulley drives, the Fenner Classic V belt has a specially treated jacket to give superior anti-static, heat and oil resistant properties.

- PB® (Precision Build) technology
- Accuracy and stability of length 'One Shot' tensioning - no matching required
- Complete range of lengths and sections
- Fully approved by all international standards

Increase Performance and Reduce Costs with a Simple Upgrade

Vee Belts offer a versatile and economical low maintenance drive which is standardised throughout the world. Fenner Classic Vee Belts are fully approved to all international standards allowing for optimised drives for compact size and economy. However, did you know that the Fenner range of Ultra PLUS wrapped wedge belts transmit significantly more power (30%) than the classical vee product and run in the same pulleys!

A well known aggregate production plant was encountering problems with a fan on their site. The maintenance team were replacing drive belts on a more and more frequent basis and the situation couldn't continue.

After a site visit, the customer was offered an alternative drive solution comprising of new pulleys and SPC4500 wedge belts. Due to the upgrade to wedge belts the customer was also able to reduce the number of drive belts from 12 to 8 which also gave the added benefit of less over hung load on the fan and motor bearings.

- Reduced energy consumption
- Power transmission significantly increased
- Increased drive performance

On-line Belt Selector

Optimising belt drive systems at the design stage can contribute significantly to the operating life, reliability and overall efficiency of a belt drive system. With this in mind we have developed the Fenner On-Line Belt Selector.



On-line Friction Belt selector:

Transmission Belts - Synchronous

Torque Drive PLUS 3

Premium belt

The state of the art Fenner Torque Drive Plus 3 (TDP3) works with standard HTD pulleys to provide the ultimate combination of power capacity, low noise and high accuracy in a belt drive.

- The highest power rating in the range
- Enhanced compounding and glassfibre cord excel in highly dynamic applications
- Ultra compact and cost effective
- Polyamide facing layer reduces noise and extends life
- Quiet operation, even at high speeds
- Replaces HTD belts to extend life and increase load capability

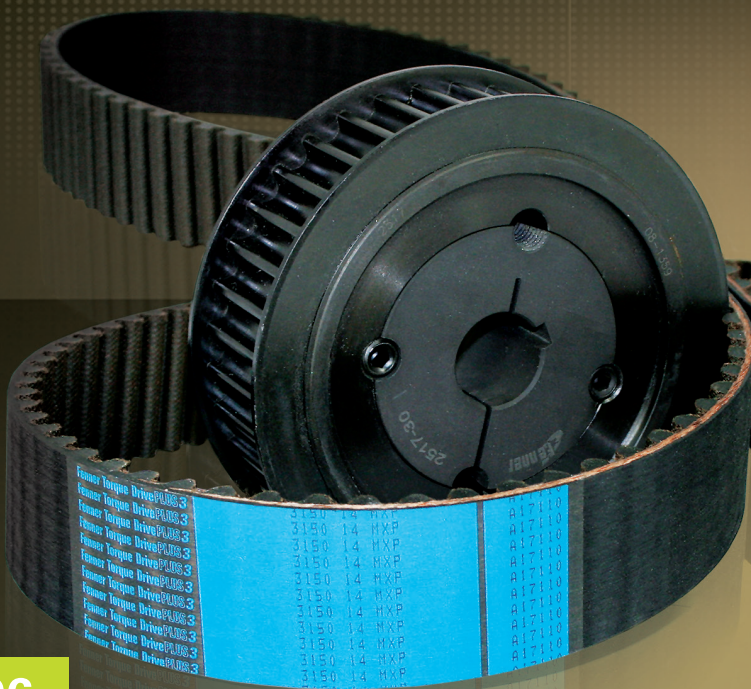

The Compact, Quiet, Powerful Solution

The outstanding performance of this third generation belt drives delivers load transmissions similar to a chain drive but with less noise, no lubrication required, no speed loss and zero "slip".

With efficiency over 96% and a high torque capacity, these belts run in standard pulleys and are always available ex-stock.

Drive Package Comparison

Torque Drive PLUS 3 Belts allow the design of lighter, more compact, more cost effective drive packages.

14MXP - 55mm



14M HTD - 115mm



XH - 178mm

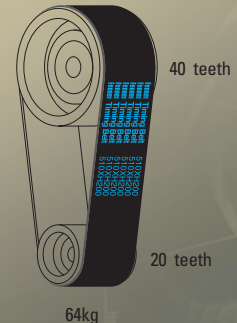

Drive condition:

Driver is a 45kW motor, 1460rev/min at 16hrs per day.
Driven machine is rotary gear pump 730rev/min \pm 5%.

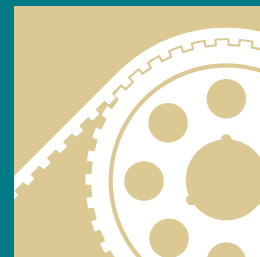

HTD Belt

Fenner® HTD timing belts are the first generation of metric 'curvilinear' tooth form synchronous belts for 'High Torque Drives'. With their associated Taper-Lock™ pulleys, they form cost-effective drives for medium duty applications.

- Curvilinear tooth improves stress distribution for higher tooth strength
- Offers a more compact drive than classical timing belt drives
- Full range of Taper-Lock® pulleys in 5, 8 and 14mm pitch
- Fully approved by all international standards
- ISO 13050 (International Standards Organisation)



Classic Timing Belt

Fenner Classical Timing Belts are the original square toothed belts. In conjunction with their associated pulleys classical belts provide an economic solution for light drive applications.

- Classical profile imperial pitch belts
- Wide range of belts and Taper-Lock® pulleys
- Efficient and economical
- Fully approved by all international standards
ISO 5296 (International Standards Organisation)
BS 4548 (British Standard)

Fenner Torque Drive PLUS 3 Belts deliver Load Transmission without Lubrication

A large UK steel manufacturer was experiencing on-going problems with one of their drives. The chain drive on a conveyor belt which carries magnets above main coal/coke conveyor was failing prematurely on a regular basis.

Following an inspection, the customer was advised to change the drive from a chain solution - that requires lubrication and periodic maintenance - to a synchronous belt drive using Fenner Torque Drive PLUS 3 (TDP3).

Fenner TDP3 is more than capable of transmitting the torque required, and easily fits into the same space envelope as the chain drive, but removes the lubrication issues that were causing premature failures.

In addition, new guarding was added to the replacement drive to direct flow of any dust which may fall from the conveyor belt, to further increase the life, and prolong the efficiency of the new belt drive.

- Dramatically reduced drive maintenance
- Highly efficient drive - up to 96% efficient
- Dry solution, no oil anywhere near the conveyor

Slab Product Availability

Fenner Classical Timing, HTD and TDP3 belts can be supplied in standard width slab form so customers can cut belts to specific required widths allowing flexibility and reduced stock holding.

In the UK and Germany, slab stock is held centrally and can be cut to any width to suit a customer's requirement. This stock, along with standard single belt stock gives the ultimate in flexibility allowing the supply of synchronous belts same day or on a breakdown basis if required.

On-line Drive Design Assistant

The Fenner Select® on-line Drive Design Assistant provides engineers with a structured, detailed approach to achieving optimum performance from the design stage onwards.



www.fptgroup.com/fennerdrivex/index.asp

Pulleys & Accessories

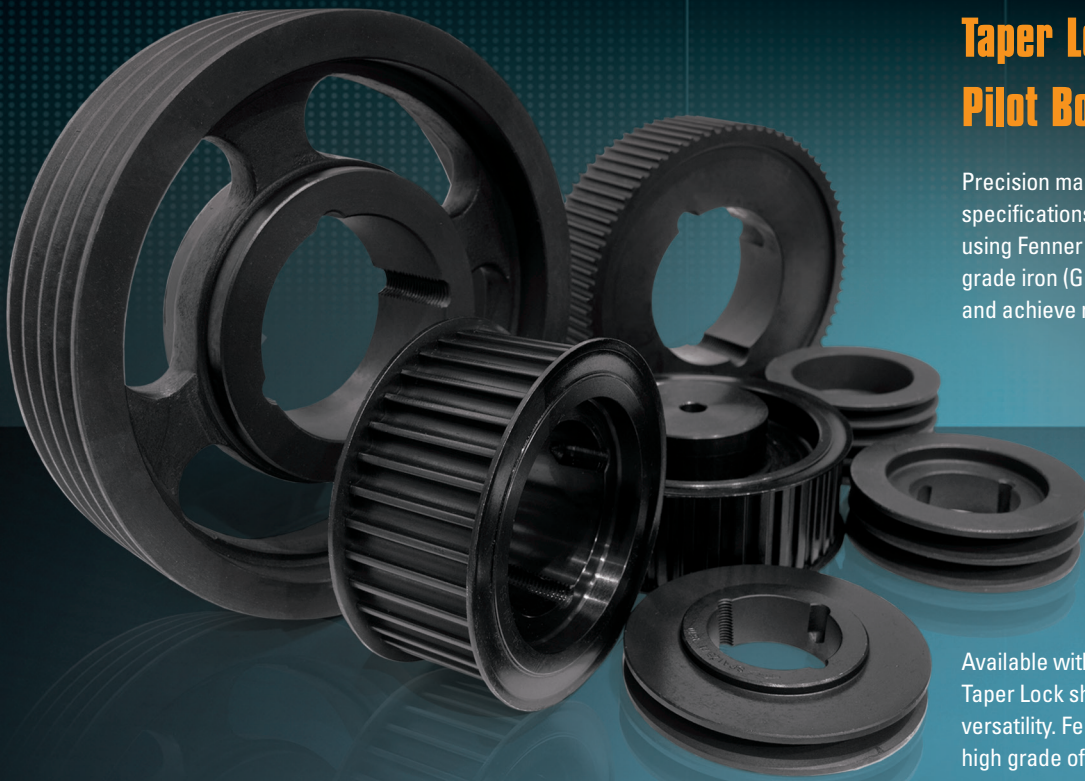

Taper Lock[®] Bush Pilot Bored Pulleys

Precision manufactured to exacting specifications thousands of engineers insist on using Fenner pulleys. Manufactured from high grade iron (GG25), they tolerate shock loading and achieve rim speeds of up to 40m/s.

Available with pilot bore fixings or using the Taper Lock shaft fixing system for ultimate versatility. Fenner friction pulleys provide a high grade of accuracy.

- Manufactured to ISO standards
- Surface treated to reduce corrosion
- Specials available

50% of new belts are fitted to worn pulleys - wasting energy and compromising the lifespan of new belts.

Replacing a worn belt but leaving a worn pulley in place will do little to restore the efficiency of a drive and the belt will have a far shorter life span than it should.

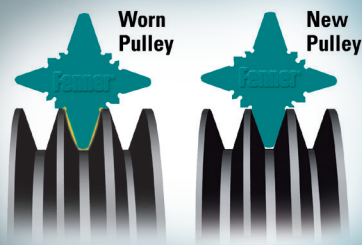

Friction Pulleys

- Dual duty grooves to ISO 4183, dual duty pulleys accept both wedge and vee belts
- High grade cast iron used for construction
- All pulleys are statically balanced
- Rim speeds to a maximum of 40m/s
- Special designs available

Synchronous Pulleys

- Available in both classical timing and HTD profiles
- Meet ISO 13050 and IS5296 standards
- High grade cast iron used for construction
- Precision machined grooves protect and maximise belt life and reduce noise
- Rim speeds up to 40m/s

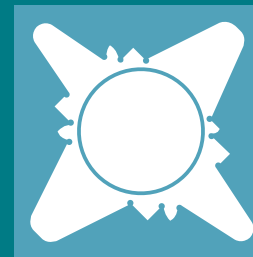

Pulley groove gauge

When installing new belts, the condition of the pulleys is often overlooked. 50% of new belts are fitted to worn pulleys - which can waste up to 10% of your energy input. The Fenner groove gauge can quickly help you assess the health of your pulleys.

- Quick, simple visual inspection tool
- Highlights pulley inefficiency due to wear



Belt Tension Indicator

Wedge belt drives can offer as much as 96% efficiency in power transmission on most applications, however to achieve and maintain such efficiency requires optimum drive design and care when installing the drives - a correctly tensioned drive avoids belt slippage that can decrease overall efficiency.

- Reduces wear on belts and pulleys
- Ensures belt drives are operating at the optimum efficiency
- Simple accurate belt tensioning



Fenner Drive Alignment Laser

The Fenner Drive Alignment Laser is the perfect tool for pulley and sprocket alignment. Applied magnetically in just a few seconds, the laser line projects onto targets allowing rapid adjustment for perfect alignment.

- Reduces wear on belts, pulleys, chain, sprockets
- Increases drive efficiency for larger energy savings
- Quick and easy to use, producing accurate results
- Shows parallel and angular misalignment
- Suitable for both vertical and horizontal mounted machines

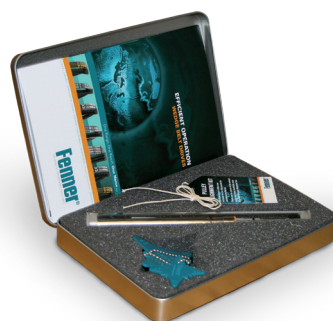

Belt Efficiency Kit

For quick and simple installation - order yours today!

The Fenner S.C.I.E.N.C.E. Explained

With Fenner it's all about the S.C.I.E.N.C.E. - Select Correctly, Install Effectively, Never Compromise Efficiency, if you adhere to these simple rules you can be confident that your drive selection will achieve optimum efficiency, full operating life and provide reliable performance.

Select Correctly

A correctly selected drive for your application will ensure the drive uses the fewest number of belts or the absolute minimum of belt width.

Install Effectively

Correct installation - once you have carefully selected your belt drive components - is paramount to the longevity and efficiency of your belt drive, by following the correct installation procedures to the letter and by using the right tools for the job, we can ensure the drive delivers its maximum rated power and efficiency.

Never Compromise Efficiency

Ensuring all your drives are an integral part of a planned maintenance schedule you can ensure the process up-time is at an absolute maximum and prolong the life of the drive.

Remember your drive stands or falls by the accuracy of its installation, so take the time to get this right and you will reap the rewards. Use the S.C.I.E.N.C.E.

On-line Drive Design Assistant

The Fenner Select® on-line Drive Design Assistant provides engineers with a structured, detailed approach to achieving optimum performance from the design stage onwards.



www.fptgroup.com/fennerdrivex/index.asp

Shaft Fixings

Taper Lock

Easy-on, easy-off

Machined to exacting tolerances in cast iron and steel, the Fenner Taper Lock® four hole bush has been tried and tested in over 50 million applications. It is the most successful shaft fixing in the market place today with a full range of both metric and imperial sizes as well as a full range of weld-on hubs, bolt-on hubs and hub adaptors.

- Ease of installation and removal
- Equivalent to a shrink-on fit on uniform load applications and thus eliminating the cost of a key
- No costly re-boring: full range of both metric and imperial available
- Standard range fits up to 125mm/5" shafts
- Special 4-hole feature for balanced assemblies
- Complete short reach range available, for compact lightweight assemblies
- High grade, close grain iron (GG25) material

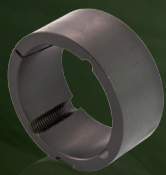

Adaptors

For use with parallel bore eliminating the cost of drilling, tapping and taper boring.

- Keyed version also available for heavy duty applications
- Taper bored to receive 4-hole Taper Lock® bush sizes 1008-4040

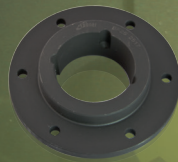

Bolt-on hubs

A convenient means to secure fan rotors, steel pulleys, plate sprockets, impellers etc. to shaft

- Welding not necessary
- Taper bored to receive 4-hole Taper Lock bush sizes 1210 to 3040

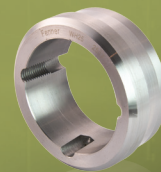

Weld-on Hubs

Manufactured from steel to provide convenient means to secure fan rotors, steel pulleys, plate sprockets, impellers etc. to a shaft.

- Shouldered outer diameter allows for easy location
- Taper bored to receive 4-hole Taper Lock bush sizes 1210 to 5040



Trantorque GTR

Trantorque GTR keyless bushing is the ideal solution for high power or critical timing applications. It offers a mechanical shrink-fit eliminating the problems of fretting corrosion, backlash and key wallowing.

- Locks and unlocks with the twist of just one nut
- Precise radial and axial adjustment on shaft. Ideal for timing components
- Trantorque GTR is "self-centering" unlike other cone clamping units. It needs no location diameter in components to retain concentricity
- Repair of damaged keyways, Just slip Trantorque GTR over the damaged keyway to effect repair
- Eliminates keyways thereby reducing shaft costs. Also allows smaller shaft as the keyway does not weaken the shaft

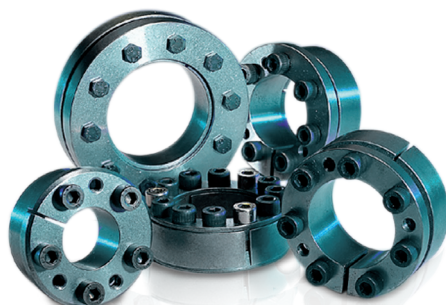

FenLock

FenLock cone-clamping elements provide a wide range of keyless shaft/hub fixing assemblies offering simple installation, increased shaft strength and high torque transmission capacity.

- Wide range of standard designs, solutions for all applications
- Eliminates the cost and complexity of keyways. Also allow the use of smaller shafts, as keyway does not weaken the shaft
- Extensive bore range from 20mm up to 900mm
- Allows for axial and angular adjustment of mounted components
- Excels at transmission high torques



To see Fenner's on-line Taper Lock installation animation please visit:
www.fptgroup.com/TL-Installation

Perfectly Balanced for Optimum Efficiency

When manufacturing Fan and HVAC drives, the OEM has to take many potential issues into account during the design phase. These range from getting the maximum efficiency from the fan to reducing bearing vibrations and extending machine life.

It is not uncommon for these types of drive to run at 2 pole motor speeds and above so vibration and noise is high on the designer's trouble shooting list and when peripheral speeds of components begin to exceed 30m/s, balancing becomes a huge issue.

It is at this point the Fenner range of Taper Lock pulleys, weld on hubs and bolt on hubs really come into their own. Not only are all Fenner pulleys statically balanced to G6.3 or better, they also utilise the Fenner four hole bush arrangement which ensures excellent assembly balance qualities and means the Fenner products can run safely at peripheral speeds of up to 40m/s.

So whether you are using a belt drive or coupling to rotate the fan or the fan is secured to the fan shaft using Fenner weld on or bolt on hubs, you can be sure of excellent balance quality and enhanced machine life when you specify Fenner Taper Lock products.

Attention to detail makes all the difference...

Because of the quality of the machining geometry, Fenner Taper Lock bushes can accept very large tolerances - +0.05 - -0.125mm

Chain Drives



Fenner PLUS Lubrication-Free Chain

Fenner PLUS lubrication-free chain is an ideal solution for situations where lubrication is difficult or contamination and fire are serious potential problems

- Built-in lubrication - Fenner PLUS lubrication-free chain has been specially manufactured to exacting standards and features its own built-in lubrication.
- Using sintered bushes impregnated with oil, Fenner lubrication-free chain can operate at up to 2.5m/sec, which is more than twice that of composite bush chains.

The Greener, Cleaner Option

Fenner PLUS Lubrication Free chain utilises sintered bush chain technology which negates the need to pre-lubricate the chain for storage or running. The porous bush is lightly impregnated with oil which gives the same performance characteristics as lubricated chain without the need for periodical applications of lubricant whilst the chain is in use.

This reduces risk to personnel as they don't have to climb into machines to lubricate product and reduces waste oil products having to be recycled safely and legally.

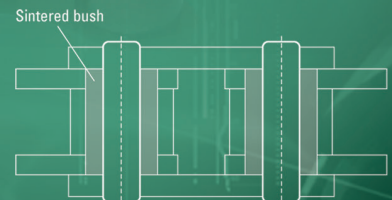
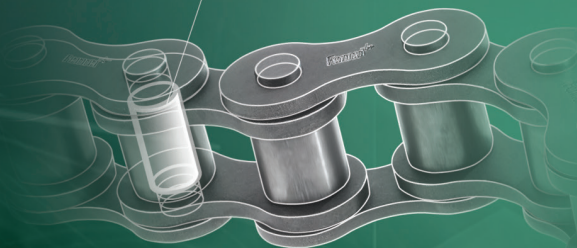

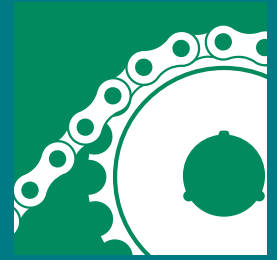

Fenner PLUS

High Performance Chain

Fenner PLUS chain builds on the heritage and engineering experience of the existing Fenner product range by optimising the benefits of performance enhancing features which work together to give Fenner PLUS chain the optimum combination of tensile strength, wear resistance and fatigue life.

- Enhanced performance in hostile environments
- Solid rollers manufactured to achieve extremely high surface hardness
- Shot peened plates for increased fatigue resistance and extended chain life
- All Fenner PLUS chain plates are progressively punched to give excellent accuracy of both diameter and pitch



Sprockets

Fenner sprockets are available with either Taper Lock® or pilot bored fixings and are precision manufactured from fine grade cast iron. Sprockets are available in simplex, duplex and triplex forms for sizes 05B to 20B.

- Fully machined 0.45% carbon steel (C45) or high grade, close grain grey iron (GG25) is used for construction
- Strict manufacturing tolerances match sprocket profiles to ISO R606 chain standards for a rolling action which significantly reduces sprocket tooth wear
- Sprockets are surface treated to reduce corrosion
- Short-reach bushes on selected sizes - compact hubs
- Induction hardened teeth on Taper Lock sprockets

Downtime Dramatically Reduced with Lube Free Chain

The German distributor for Fenner Power Transmission was contacted by a large pet food manufacturer, as they were experiencing problems with the roller chains on their pet food conveyors.

The chains were failing after just six months of use, and were also contaminated with debris attracted by excess oil which had been applied to the products. Following a site visit and after a lengthy technical discussion it was recommended that Fenner PLUS lubrication-free roller chain would be the best solution. Not only would this negate the need for costly and time consuming maintenance procedures, it would save the customer the expense of recycling the oil based lubricant after use.

100 metres were subsequently trialled, and a year later are still performing! The end user is delighted not only with the enhanced performance, but also with the lube-free benefits using this product resulting in an environmentally friendly factory. All conveyor lines have been and will continue to be fitted with Fenner PLUS lubrication-free roller chain.



Attention to detail makes all the difference...

Progressive punching for holes and sideplates guarantees pitch accuracy and enables easy hand tool extraction.

Couplings



Fenaflex Tyre Couplings

Fenaflex Tyre Couplings are highly elastic, lubrication free couplings that tolerate large amounts of misalignment in all planes as well as offering simple installation and inspection without disrupting the drive. The Fenaflex™ coupling also has excellent shock absorbing properties while reducing vibration and torsional oscillations.

- Simple time saving installation
- Large misalignment capability, 4° angular, up to 6mm parallel and 8mm axial
- Internal load carrying cords are wound in both directions, so there is no problem on reversing drives
- Tyres are available in standard and FRAS (Fire Resistant Anti Static) construction. ATEX approved.
- Simple visual inspection to aid maintenance
- Pump spacer and flywheel fixing variants available

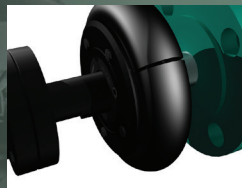

Couplings

Available in taper lock or pilot bore flanges, Taper Lock® have a massive torque capacity and are available with a fire resistant, anti static tyre.

Fenaflex Pump Spacer Variant

Spacer variant available for pump drives to allow disassembly of pump shaft without disturbing the prime mover, minimising downtime.

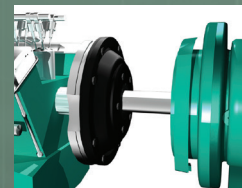

Fenaflex Flywheel Variant

Flywheel coupling version available for standard SAE flywheel fixings and elements available in different dynamic stiffness's to accommodate a wide range of engine and driven machine parameters.

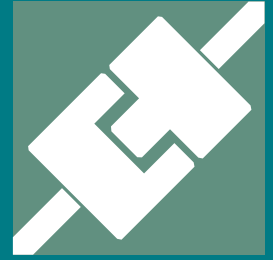

HRC Couplings

Permitting quick and easy installation by means of Taper Lock® bushes, and offering quick alignment, the semi-elastic general purpose HRC coupling is ideal for use with electric motors.

- Ease of alignment and fitting using straight edge and machined outside diameters
- Fail-safe design due to interacting dog design
- Accommodates incidental misalignment
- Standard and FRAS elements available
- Flywheel fixing variant available
- Pilot bore design also available



Jaw Couplings

Absorbing incidental misalignment, shock loads and small amplitude vibrations, Fenner Jaw couplings offer a low cost flexible solution for most applications.

- Ease of alignment
- Fail-safe shaft connection
- Range of element materials available including nitrile, urethane and hytrel
- Pump spacer variant available
- Design powers up to 42.2kW available at 1440rpm



Rigid Couplings

Taper Lock® rigid couplings provide a convenient method of rigidly connecting the ends of shafts. Taper Lock® bushes permit easier and quicker fixing to the shafts with the firmness of a shrunk-on-fit.

- Taper Lock® fixing as standard
- Peripheral speeds of up to 33m/s available
- Vertical assemblies possible in FF design

Customised Solutions from Fenner

When a large paper and board customer needed a Fenaflex coupling to work with engine/pump sets that used 3-cylinder engines with an SAE 6.1/2 flywheel, there was a small problem - it wasn't a standard Fenner product because the smallest Fenaflex coupling was designed to fit an SAE 7.1/2 flywheel.

It wasn't a problem for long. A special variant was designed with a sufficiently large driven side to accommodate the power of the engine. Ensuring that the dynamic torsional stiffness was correct, involved some innovative thinking by the Design Engineers and Material Specialists to develop the perfect Fenaflex solution.

The rubber element moulds and metal part tooling were specified and put into production extremely quickly - and the customer has been using the resulting product exclusively.



Attention to detail makes all the difference...

Avoid the need to remove the driven machine or prime mover when carrying out maintenance by using our specially designed spacer version.

Why Fenner?

No other product brand can provide you with a complete drive solution.
From initial electrical input through to final driven machine.

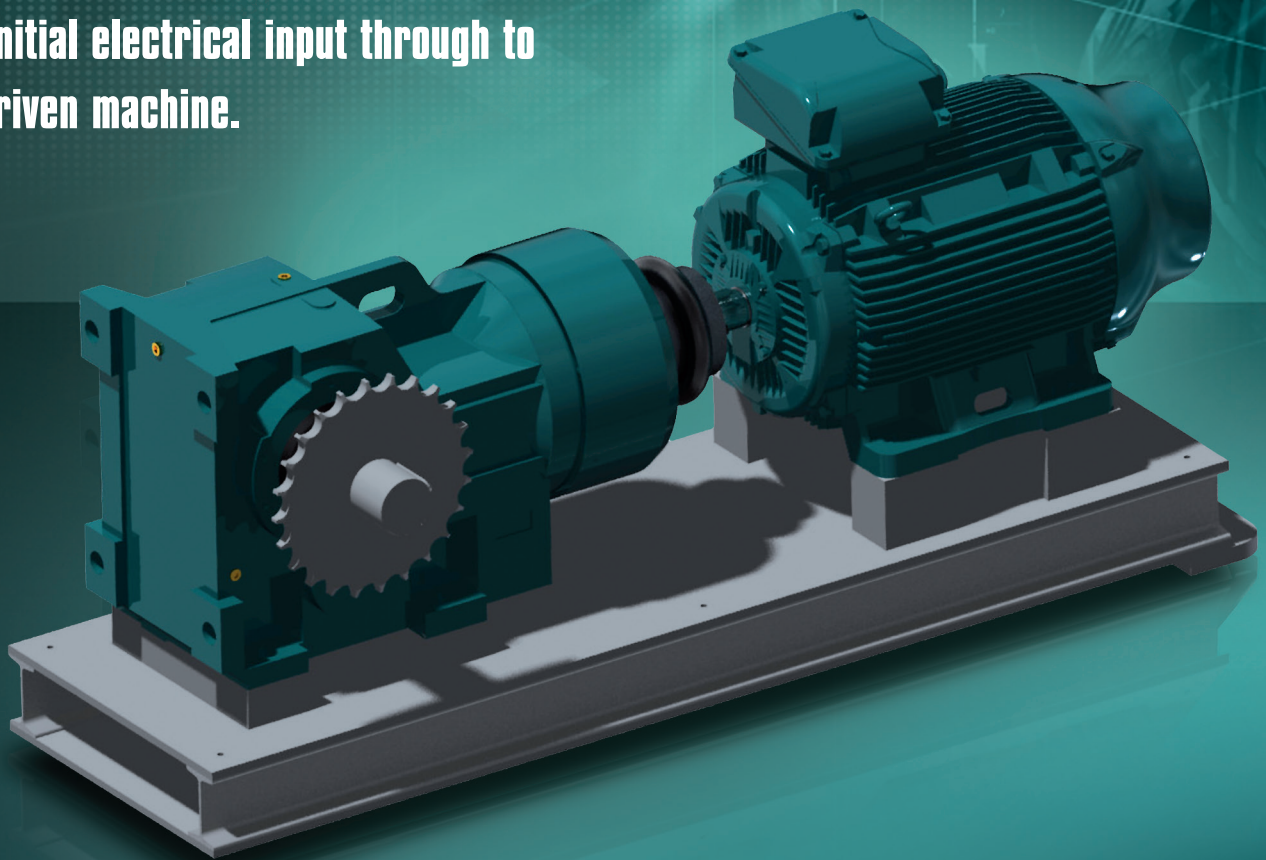

Total Package Saving

Each range within the Fenner portfolio has been designed to provide the optimum efficiency and latest innovation underpinned by Fenner reliability and rugged performance.

By combining additional elements across the Fenner range you are assured of quality, precision and performance delivering a trouble-free operating life and increased efficiency.

Technical Advice

Only by working alongside approved Fenner distributors are you guaranteed the highest standard of technical advice, both pre and post sale, helping you make the most efficient and cost effective drive selection using the latest innovations for tomorrows standards.

Simple Service Supply

- One contact point
- One invoice
- One warranty
- Full product traceability

One Name, One Range, One Result - Driven Performance



Tomorrow's Solutions Today

Fenner products continue to deliver innovative improvements in product performance, reliability and safety. When used together as part of a drive package, the resultant gains in

lifetime cost-effectiveness are complemented by a reduction in maintenance, simplified installation and through Fenner's advanced engineering design.

Typical Fan Application

Today: Old Installation

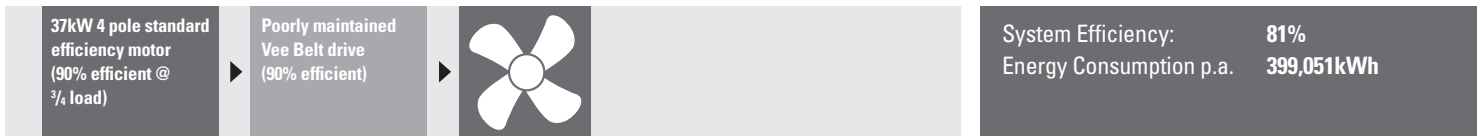

Tomorrow: The Fenner Solution

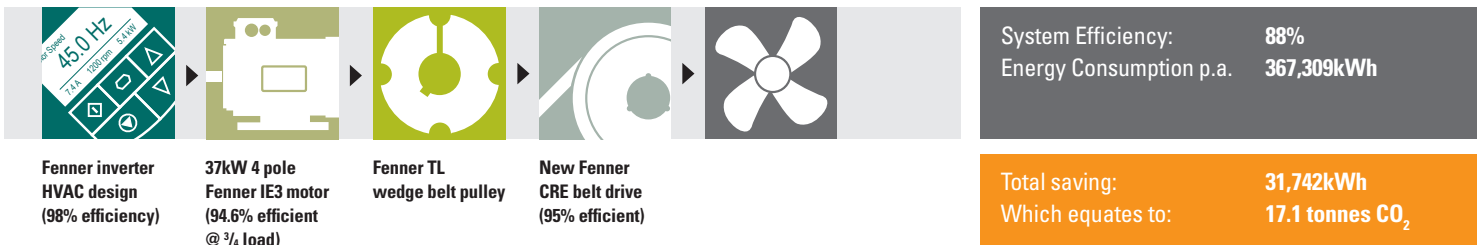

Typical Conveyor Application

Today: Old Installation

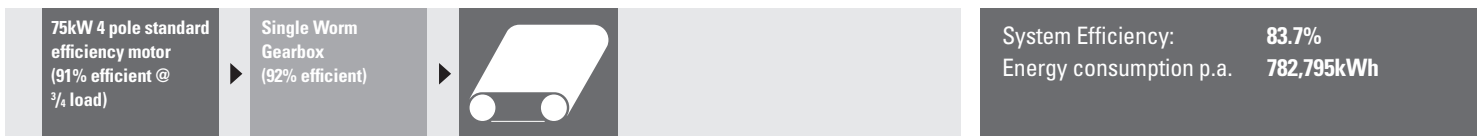

Tomorrow: The Fenner Solution

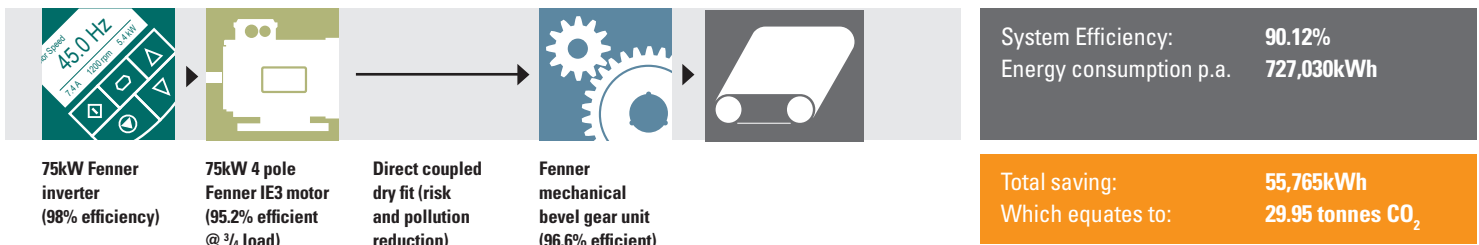

Industry - Tried and Tested

United Kingdom

One of the world's leading mobile heat exchanger manufacturers looked to Fenner Ultra PLUS wedge belt products when they experienced inconsistency in belt lengths on radiator fan drives. This inconsistency propagates uneven load sharing by the belts on the drive and leads to premature failure. As the units are located all over the world and can be in inaccessible hostile environments, this situation was not acceptable. The Fenner products specified are precision built to the exacting standards ISO4184 - DIN7753 - BS3790 - RMAIP22 and are also static conductive to IS1813. The problem has not occurred since the change to the Fenner products.

Germany

An OEM in Bonn has introduced a new range of extruding machines, during the trials, the sourced SPB wedge belts were squealing and smoking during start up mode. Installing Fenner Quattro Plus wedge belts solved the problem. Not only does the enhanced power rating of the Quattro Plus range enable smooth operation of their extruding machines, energy is also conserved thanks to the high efficiency (96%) of these belts.

Portugal

A Portuguese agricultural OEM has been converted from using traditional bore and keywayed pulleys to the Fenner Taper Lock Bush system. The OEM is delighted by the cost and energy saving as the entire boring and keywaying operation is now not necessary, also by the ease of fitting our system in his factory.

Ghana

Fenner PLUS Chain provides the optimum combination of tensile strength, wear resistance and fatigue life, offering enhanced performance in hostile environments. The product also utilises a dry wax lubricant ensuring dust and debris do not stick to the chain and get transferred to the bearing area which can cause wear and premature failure. These attributes make Fenner Plus the perfect all round solution for Ghana's largest flour mill.

South Africa

Fenner has had a presence in S.A. since 1928 and is a household name in the mining industry with a 60%+ share of the drive belt market. The introduction of Fenner Vee and Wedge belts into mines across Africa has resulted in a significant reduction in maintenance costs and down time. This is due to the superior tensioning ability of these belts that eliminate belt slip.





Sweden

A large steel mill were experiencing severe vibration issues and leakages on their conveyor lines. A simple switch to Fenaflex Couplings solved their issues and has since become the coupling of choice - The Fenaflex range can easily accommodate the application misalignment and has excellent shock absorbing properties while reducing vibration and torsional oscillations.



Russia

Fenner SMSR gearboxes have become the unit of choice in for Russian steel mills. A large OEM who manufacture pumps for their coal mining industry rely on Fenaflex Couplings and depending on the type of pump, Fenner pulley drives with Quattro PLUS wedge belts.



Egypt

Fenner Shaft Mounted Speed Reducers (SMSR) have become the gearbox of choice in Egypt's construction industry. The modular design allows the unit to be mounted in a number of ways providing reliable, rugged performance in the harshest of environments.



Singapore

The Fenaflex tyre coupling is widely recognised as the product of choice for pump applications. The highly torsionally elastic tyre element is flexible enough to accept large misalignment capacity in all planes combined with excellent shock absorbing properties. The spacer design variant allows driven machine or prime mover maintenance without disturbing either.



United Arab Emirates

In challenging climates leading HVAC OEM's in the UAE depend on Fenner wedge belts. The increased service life and reliable performance provided by Fenner drives has extended maintenance routines from 12 to 24 months.



Australia

One of the most demanding and harsh environments for drive products on the planet has to be in open cast mines and quarries in Australia. By utilising the very latest in material technology (Aramid fibre cords, fibre reinforced polychloroprene rubber and asymmetric weave high grade polyester jacket) and state of the art production techniques we were able to develop a solution to satisfy these very demanding applications. The Fenner UP150 belt is now solving customer's problems worldwide and reducing downtime to an absolute minimum thus producing real tangible cost savings.

Fenner - Setting the Standard

With a valued heritage stretching back over 150 years, Fenner Power Transmission products continue to be recognised worldwide for their ability to deliver a dependable combination of exacting specification, rugged construction and efficient performance.

This commitment to quality, backed by extensive product development and innovation has seen Fenner grow into a mature brand with true global reach across six continents.

Join Fenner On-line

 www.fptgroup.com

 [@FennerPT](https://twitter.com/FennerPT)

 www.facebook.com/FennerPt



▶ www.fptgroup.com

MAAGTECHNIC

Maagtechnic AG

Sonnentalstrasse 8,
CH-8600 Dübendorf

Tel: +41 (0)848 111 333 Fax: +41 (0)848 111 334

Maagtechnic AG

Chemin de Mongevon 23,
CH-1023 Crissier

Tel: +41 (0)848 111 666 Fax: +41 (0)848 111 667



Fenner, Fenaflex, Fenner Power Plus, Fenner Torque Drive Plus, PowerTwist, FenLock and Trantorque are registered trade marks of J. H. Fenner & Co. Taper Lock, Power Plus, PB, and Bi-Loc are registered trade marks of ERIKS Industrial Services